

Speech Recognition and Synthesis



Dan Klein
UC Berkeley



Language Models





Noisy Channel Model: ASR

- We want to predict a sentence given acoustics:

$$w^* = \arg \max_w P(w|a)$$

- The noisy-channel approach:

$$\begin{aligned} w^* &= \arg \max_w P(w|a) \\ &= \arg \max_w P(a|w)P(w)/P(a) \\ &\propto \arg \max_w P(a|w)P(w) \end{aligned}$$

Acoustic model: score fit
between sounds and words

Language model: score
plausibility of word sequences

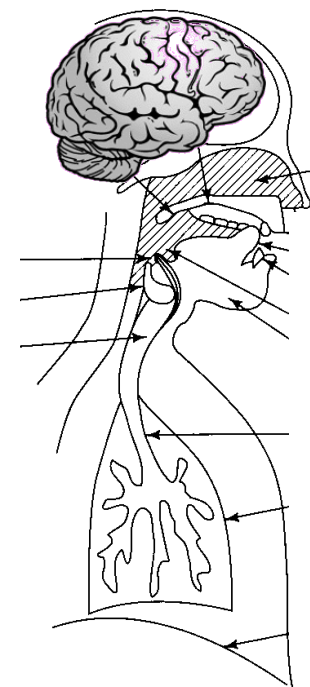

The Speech Signal



Speech in a Slide

- Frequency gives pitch; amplitude gives volume

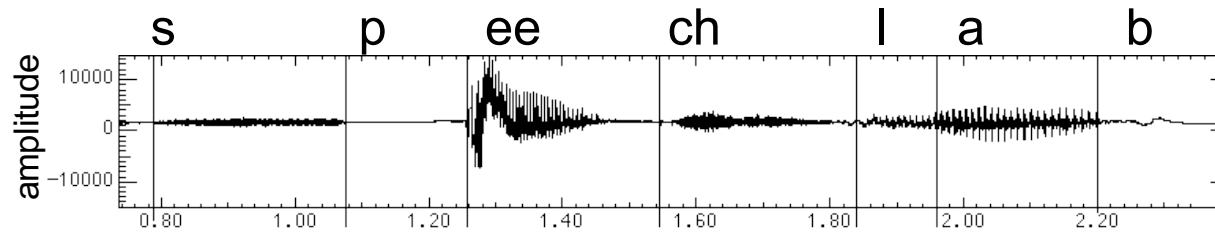

- Frequencies at each time slice processed into observation vectors

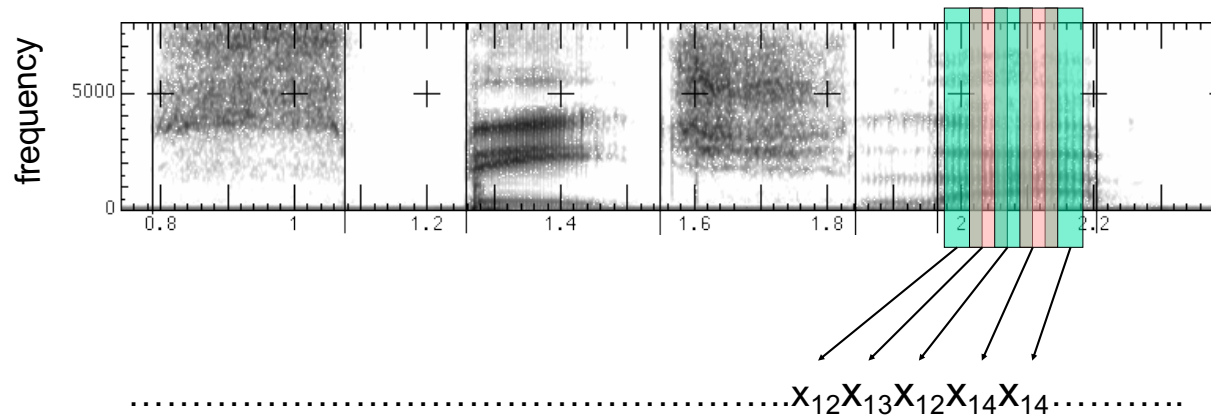

Articulation



Articulatory System

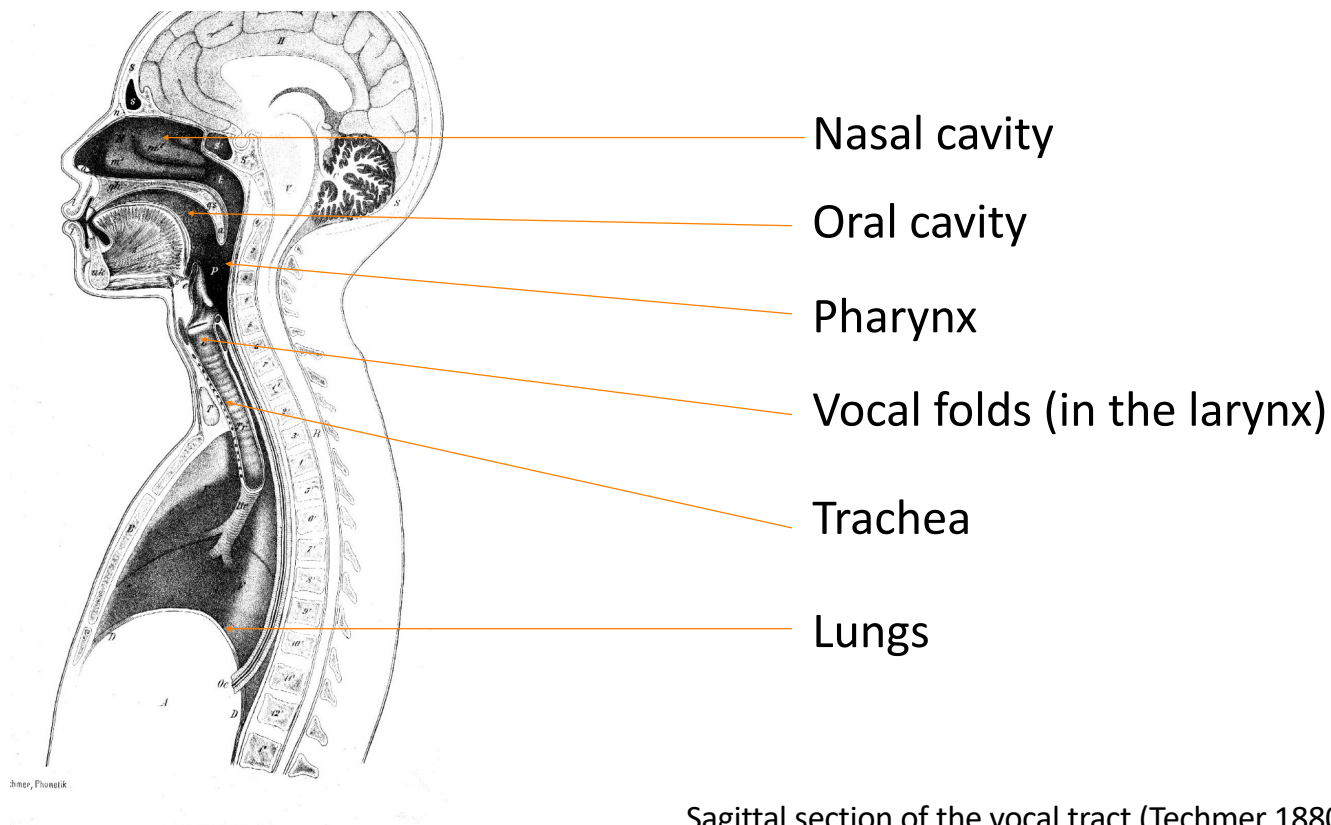

Sagittal section of the vocal tract (Techmer 1880)

Text from Ohala, Sept 2001, from Sharon Rose slide



Space of Phonemes

- Standard international phonetic alphabet (IPA) chart of consonants

	LABIAL		CORONAL				DORSAL			RADICAL		LARYNGEAL
	Bilabial	Labio-dental	Dental	Alveolar	Palato-alveolar	Retroflex	Palatal	Velar	Uvular	Pharyngeal	Epi-glottal	Glottal
Nasal	m	ɱ	n			ɳ	ɲ	ŋ	ɴ			
Plosive	p b	ɸ β	t d			ʈ ɖ	c ɟ	k ɡ	q ɢ			
Fricative	ɸ β	f v	θ ð	s z	ʃ ʒ	ʂ ʐ	ç ʝ	x ɣ	χ ʁ	ħ ʕ	ħ ʕ	h ɦ
Approximant		ʋ	ɹ			ɻ	j	ɰ				
Trill	ʙ		r						ʀ		ʀ	
Tap, Flap		ⱱ	ɾ			ɽ						
Lateral fricative			ɬ ɮ			ɮ	ɬ	ɮ				
Lateral approximant			l				ɭ	ʎ	ʟ			
Lateral flap			ɭ				ɮ					

Articulation: Place



Places of Articulation

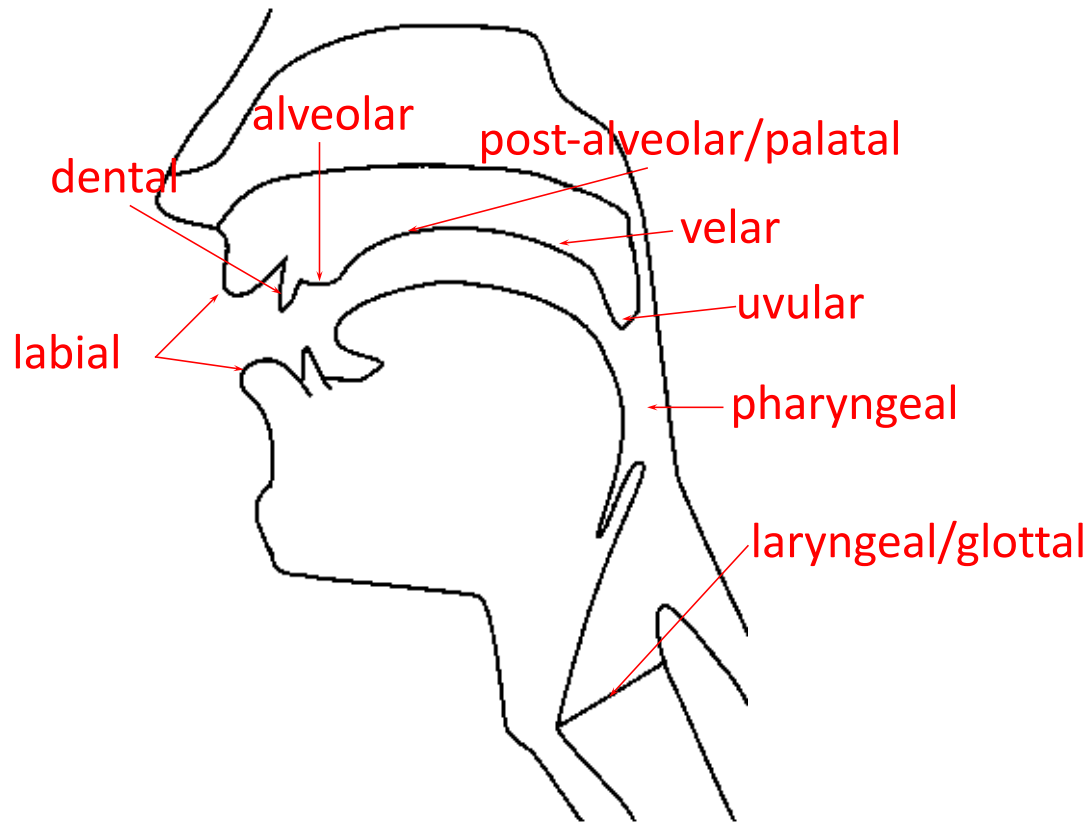
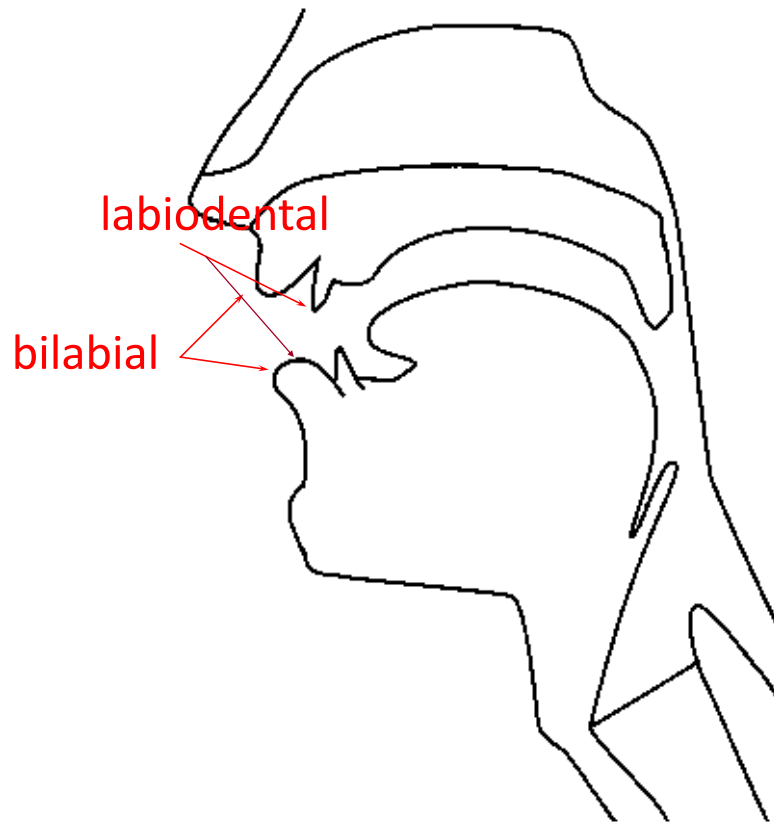

Figure thanks to Jennifer Venditti



Labial place



Bilabial:

p, b, m

Labiodental:

f, v

Figure thanks to Jennifer Venditti



Coronal place

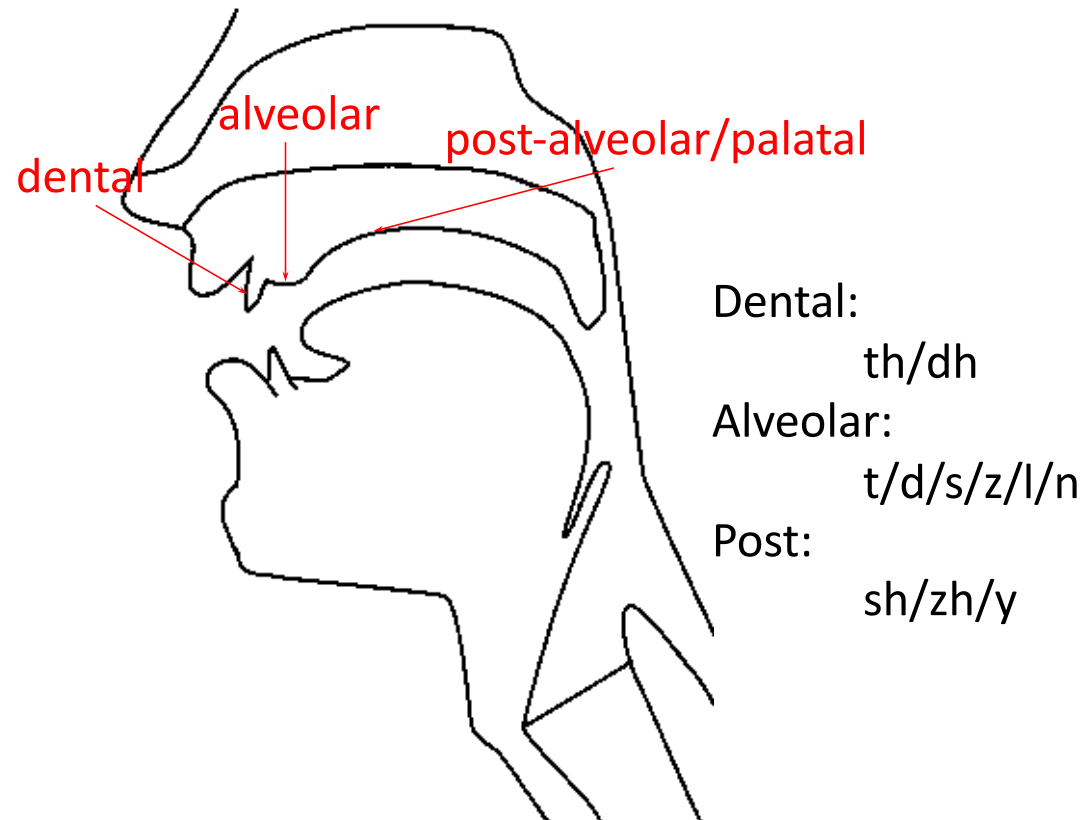

Figure thanks to Jennifer Venditti



Dorsal Place

Velar:
k/g/ng

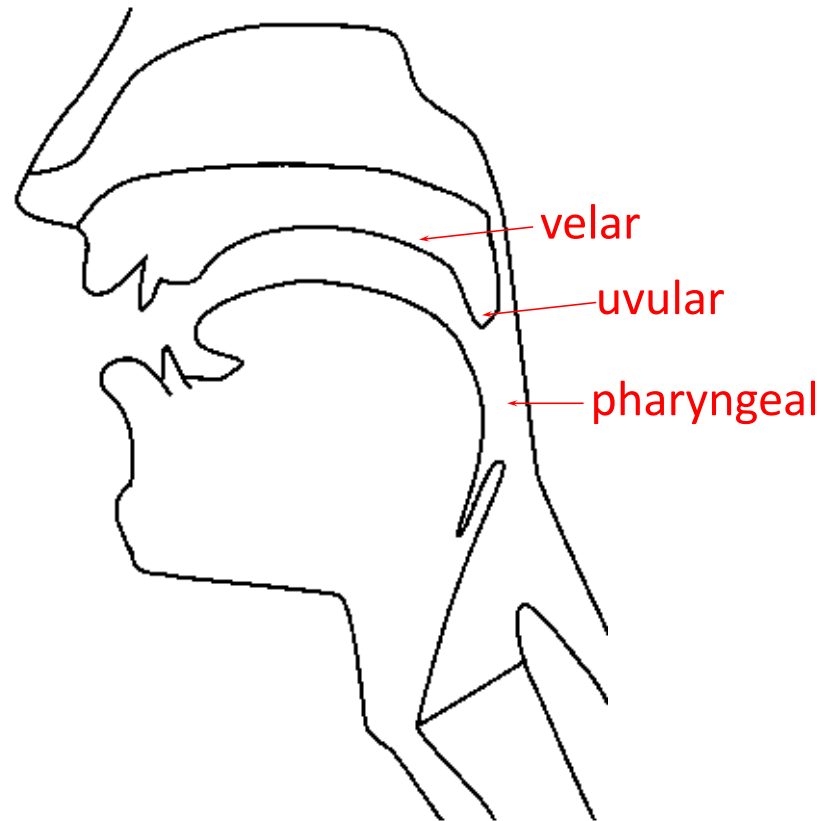

Figure thanks to Jennifer Venditti



Space of Phonemes

- Standard international phonetic alphabet (IPA) chart of consonants

	LABIAL		CORONAL				DORSAL			RADICAL		LARYNGEAL
	Bilabial	Labio-dental	Dental	Alveolar	Palato-alveolar	Retroflex	Palatal	Velar	Uvular	Pharyngeal	Epi-glottal	Glottal
Nasal	m	ɱ	n			ɳ	ɲ	ŋ	ɴ			
Plosive	p b	ɸ β	t d			ʈ ɖ	c ɟ	k ɡ	q ɢ			
Fricative	ɸ β	f v	θ ð	s z	ʃ ʒ	ʂ ʐ	ç ʝ	x ɣ	χ ʁ	ħ ʕ	ħ ʕ	h ɦ
Approximant		ʋ	ɹ			ɻ	j	ɰ				
Trill	ʙ		r						ʀ		ʀ	
Tap, Flap		ⱱ	ɾ			ɽ						
Lateral fricative			ɬ ɮ			ɮ	ɬ	ɮ				
Lateral approximant			l				ɭ	ʎ	ʎ			
Lateral flap			ɭ				ɭ					

Articulation: Manner



Manner of Articulation

- In addition to varying by place, sounds vary by manner
- Stop: complete closure of articulators, no air escapes via mouth
 - Oral stop: palate is raised (p, t, k, b, d, g)
 - Nasal stop: oral closure, but palate is lowered (m, n, ng)
- Fricatives: substantial closure, turbulent: (f, v, s, z)
- Approximants: slight closure, sonorant: (l, r, w)
- Vowels: no closure, sonorant: (i, e, a)

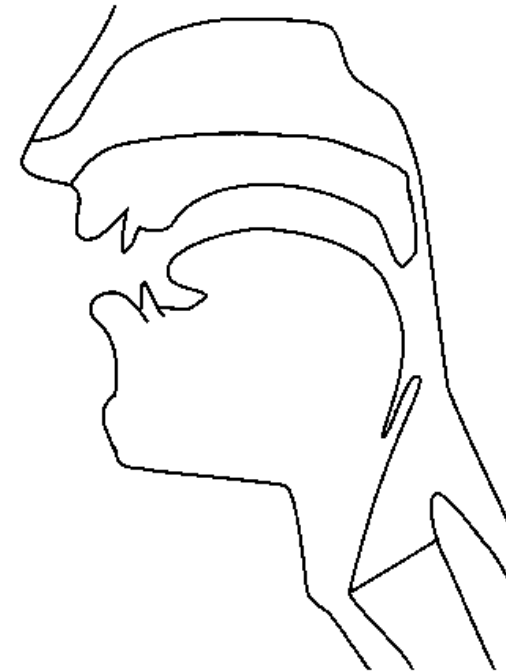



Space of Phonemes

- Standard international phonetic alphabet (IPA) chart of consonants

	LABIAL		CORONAL				DORSAL			RADICAL		LARYNGEAL
	Bilabial	Labio-dental	Dental	Alveolar	Palato-alveolar	Retroflex	Palatal	Velar	Uvular	Pharyngeal	Epi-glottal	Glottal
Nasal	m	ɱ	n			ɳ	ɲ	ŋ	ɴ			
Plosive	p b	ɸ β	t d			ʈ ɖ	c ɟ	k ɡ	q ɢ			
Fricative	ɸ β	f v	θ ð	s z	ʃ ʒ	ʂ ʐ	ç ʝ	x ɣ	χ ʁ	ħ ʕ	ħ ʕ	h ɦ
Approximant		ʋ	ɹ			ɻ	j	ɰ				
Trill	ʙ		r						ʀ		ʀ	
Tap, Flap		ⱱ	ɾ			ɽ						
Lateral fricative			ɬ ɮ			ɮ	ɬ	ɮ				
Lateral approximant			l			ɭ	ʎ	ʎ				
Lateral flap			ɭ			ɮ						

Articulation: Vowels



Vowel Space

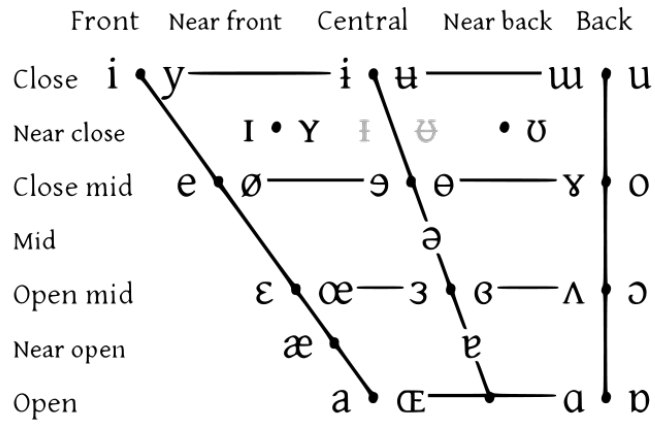
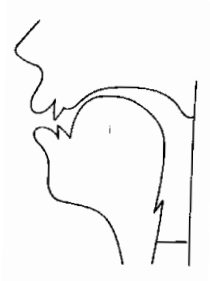

Vowels at right & left of bullets are rounded & unrounded.

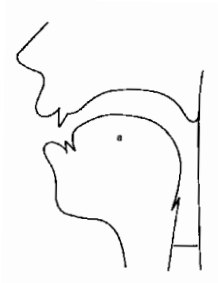

Acoustics



“She just had a baby”

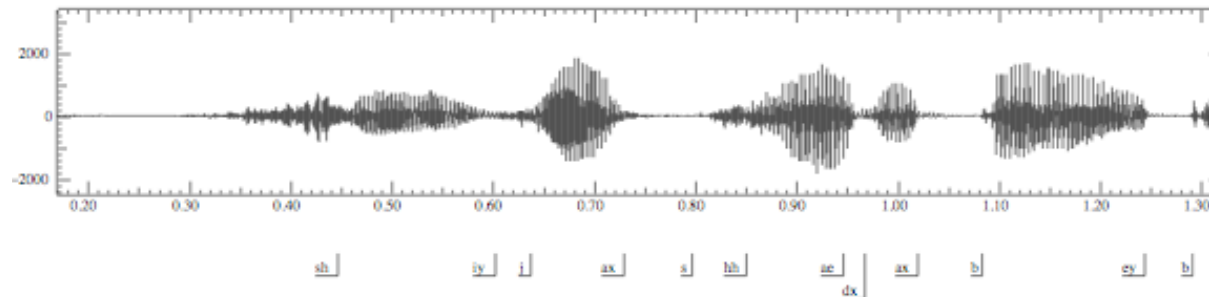

What can we learn from a wavefile?

- No gaps between words (!)
- Vowels are voiced, long, loud
- Length in time = length in space in waveform picture
- Voicing: regular peaks in amplitude
- When stops closed: no peaks, silence
- Peaks = voicing: .46 to .58 (vowel [iy], from second .65 to .74 (vowel [ax]) and so on
- Silence of stop closure (1.06 to 1.08 for first [b], or 1.26 to 1.28 for second [b])
- Fricatives like [sh]: intense irregular pattern; see .33 to .46



Time-Domain Information

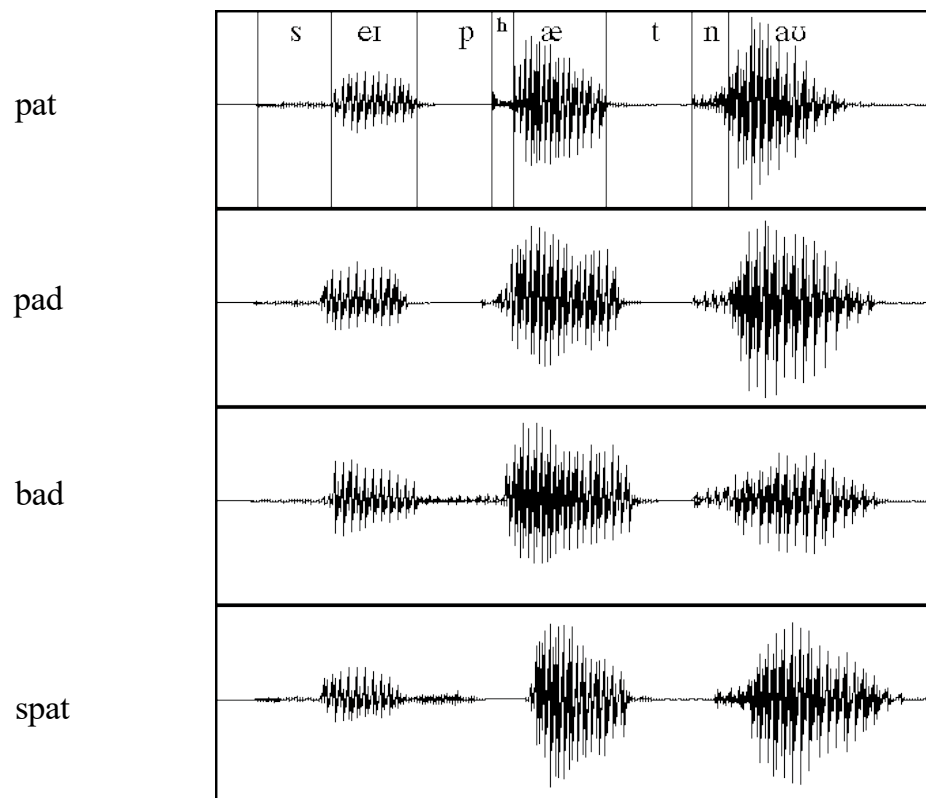

Example from Ladefoged



Simple Periodic Waves of Sound

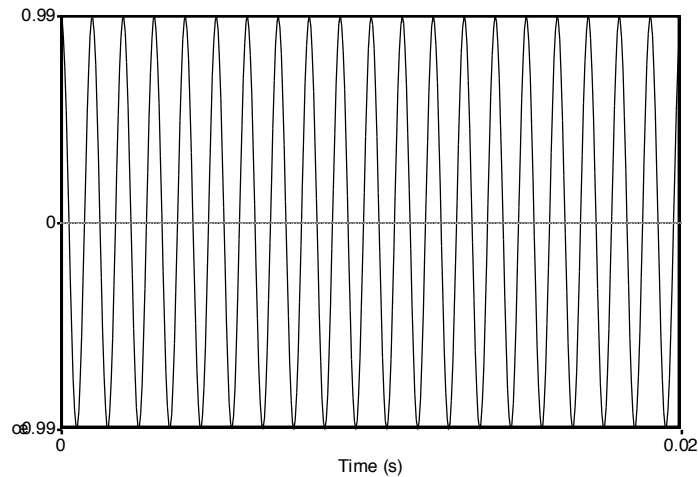

- Y axis: Amplitude = amount of air pressure at that point in time
 - Zero is normal air pressure, negative is rarefaction
- X axis: Time
- Frequency = number of cycles per second
- 20 cycles in .02 seconds = 1000 cycles/second = 1000 Hz



Complex Waves: 100Hz+1000Hz

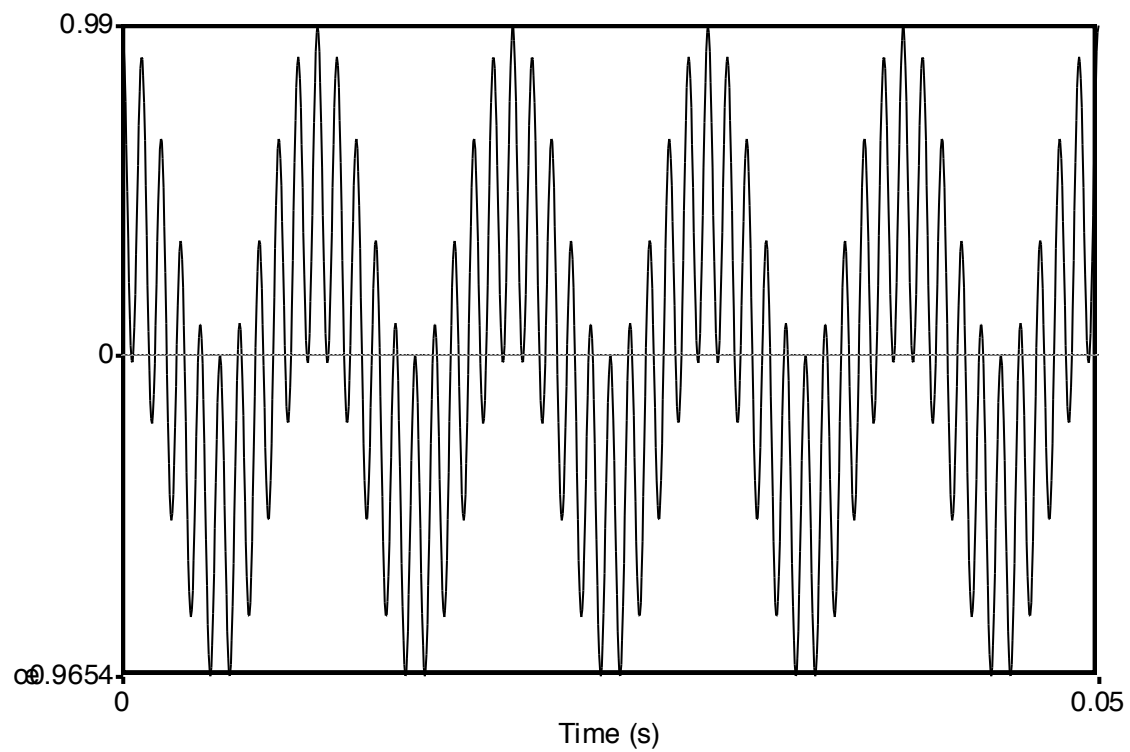



Spectrum

Frequency components (100 and 1000 Hz) on x-axis

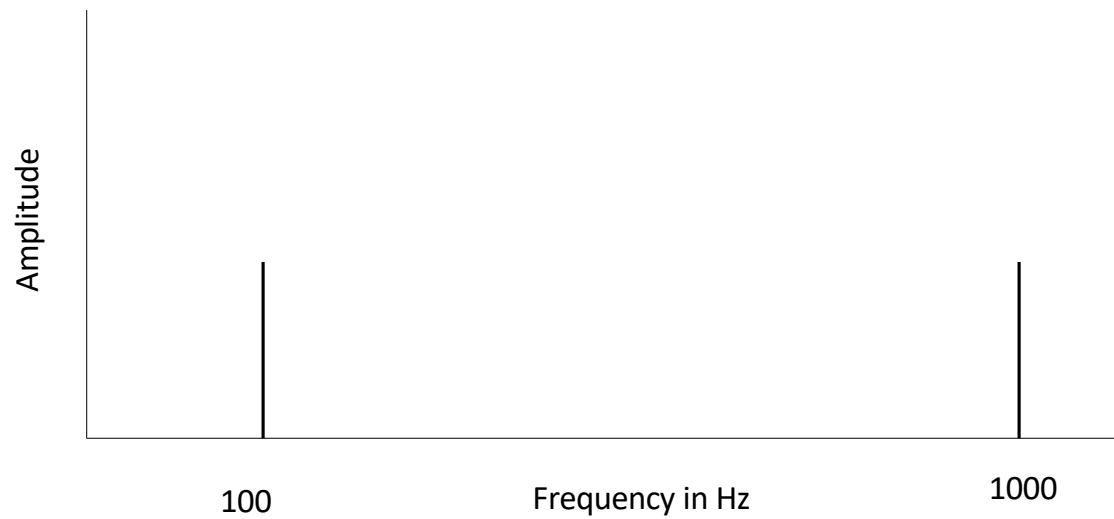



Part of [ae] waveform from “had”

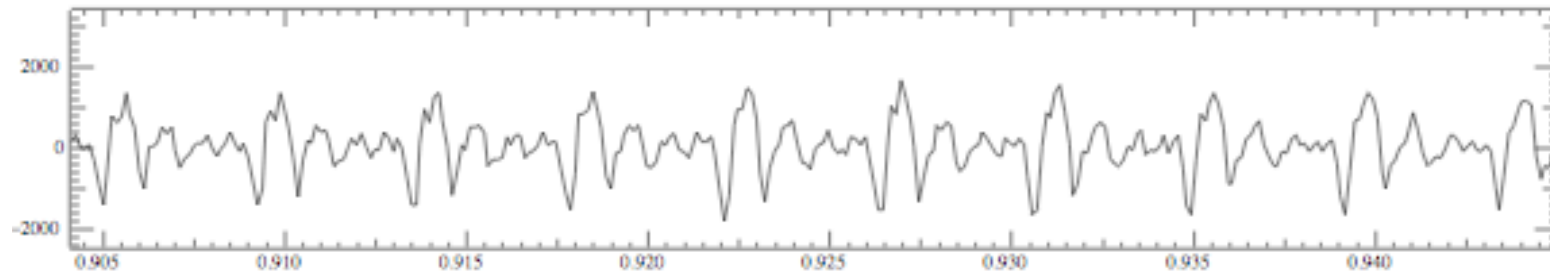

- Note complex wave repeating nine times in figure
- Plus smaller waves which repeats 4 times for every large pattern
- Large wave has frequency of 250 Hz (9 times in .036 seconds)
- Small wave roughly 4 times this, or roughly 1000 Hz
- Two little tiny waves on top of peak of 1000 Hz waves



Spectrum of an Actual Soundwave

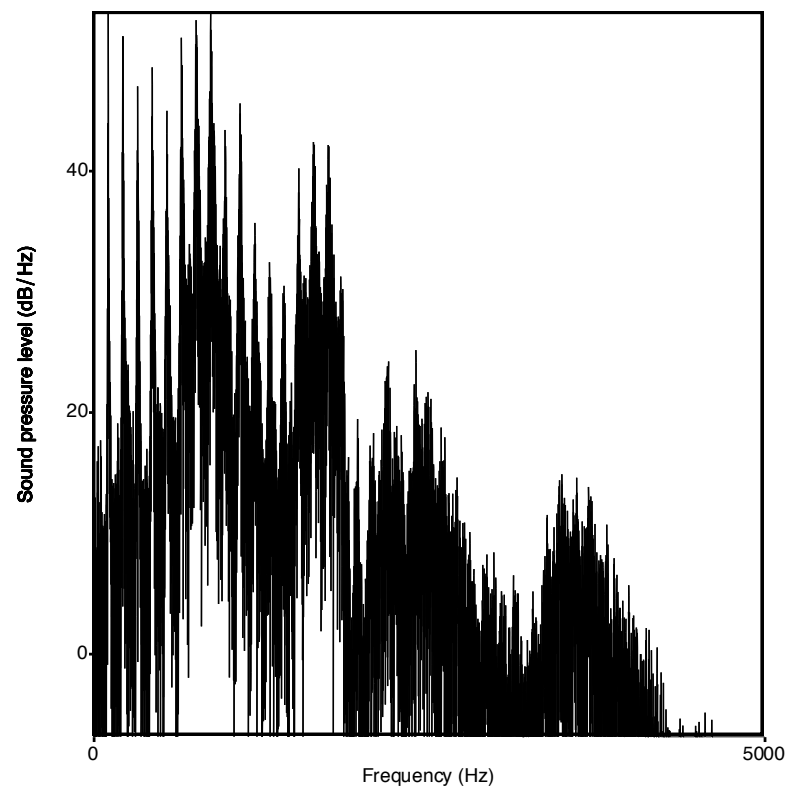

Source / Channel

Why these Peaks?

- **Articulation process:**
 - The vocal cord vibrations create harmonics
 - The mouth is an amplifier
 - Depending on shape of mouth, some harmonics are amplified more than others

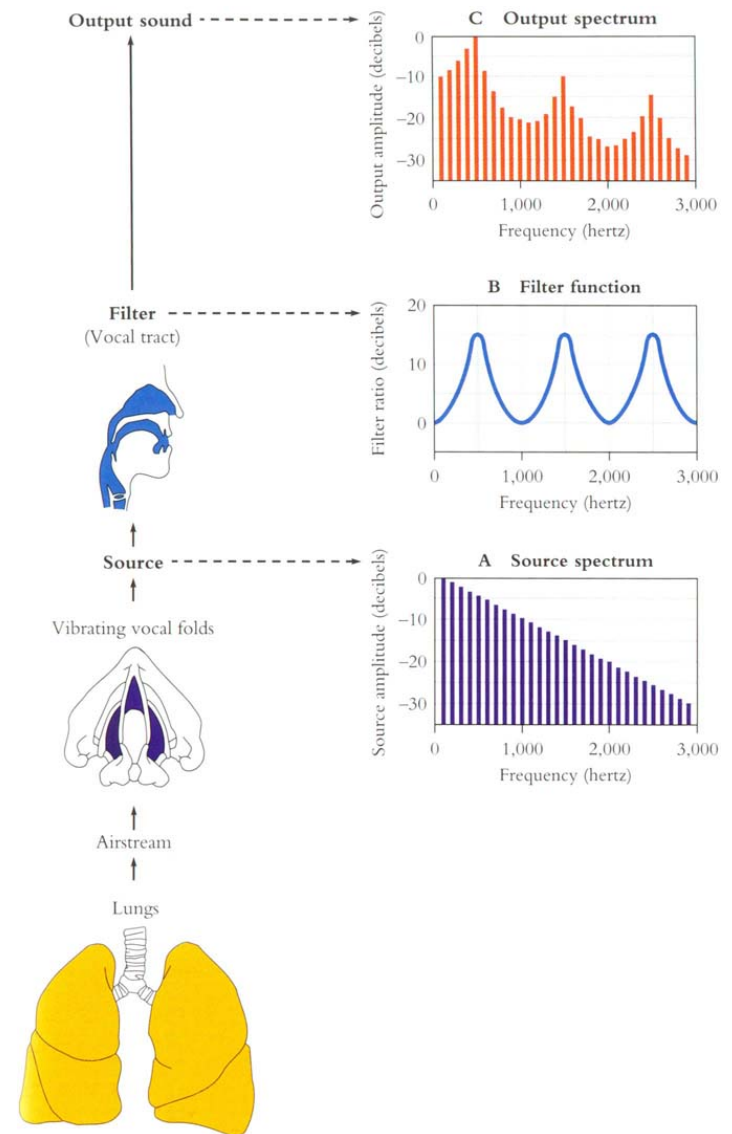



Vowel [i] at increasing pitches

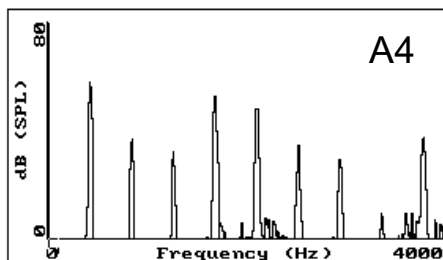
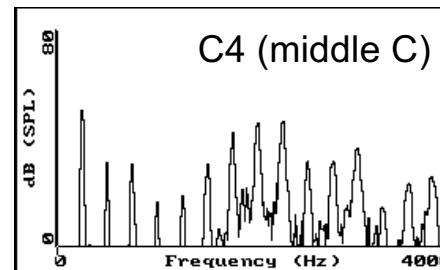
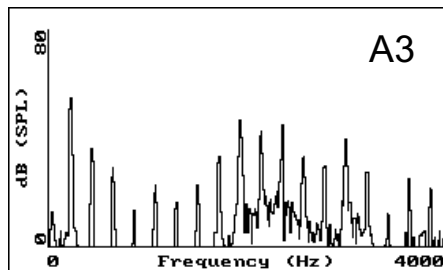
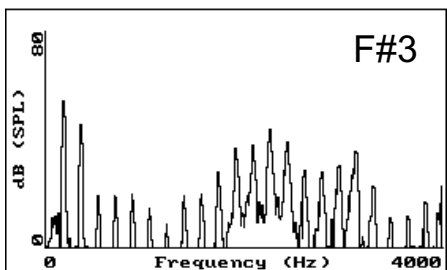
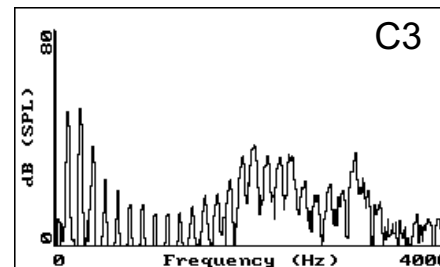
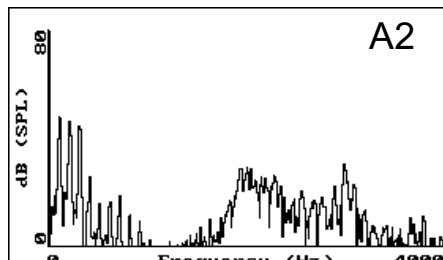
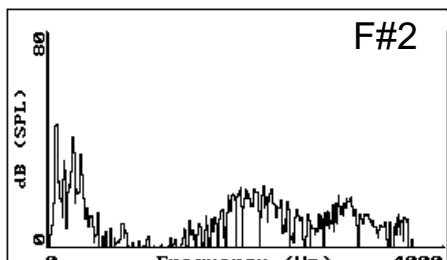

Figures from Ratree Wayland



Resonances of the Vocal Tract

- The human vocal tract as an open tube:

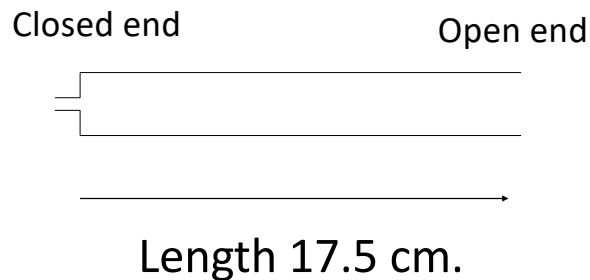

- Air in a tube of a given length will tend to vibrate at resonance frequency of tube.
- Constraint: Pressure differential should be maximal at (closed) glottal end and minimal at (open) lip end.

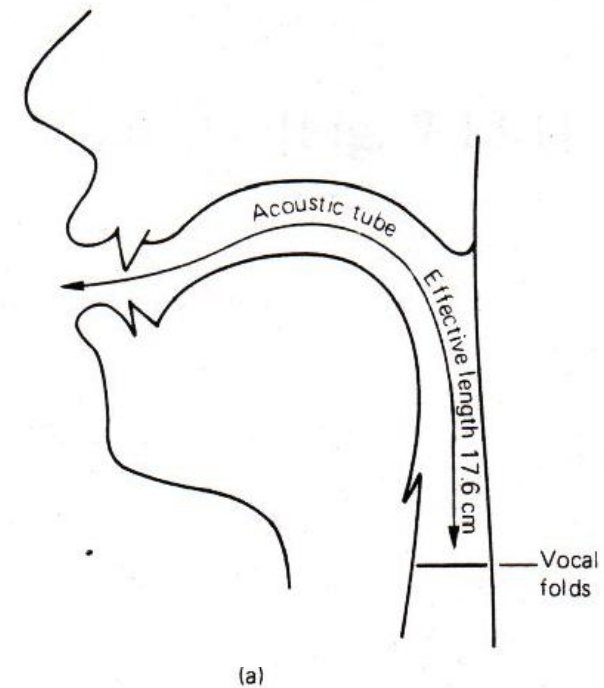
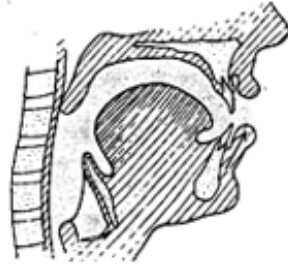
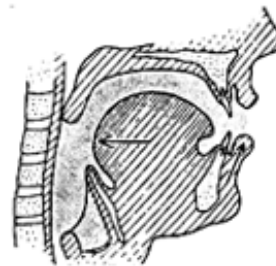
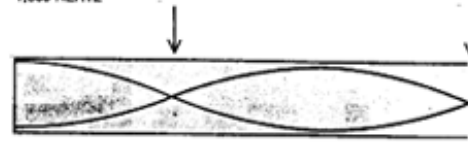

Figure from W. Barry

FIRST FORMANT
1/4 WAVELENGTH
500 HERTZ



SECOND FORMANT
3/4 WAVELENGTH
1,500 HERTZ



THIRD FORMANT
5/4 WAVELENGTH
2,500 HERTZ

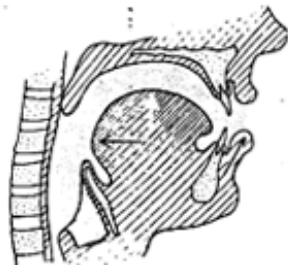
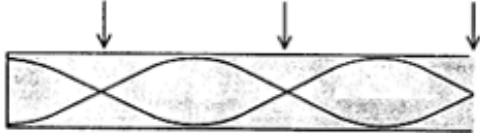

FOURTH FORMANT
7/4 WAVELENGTH
3,500 HERTZ

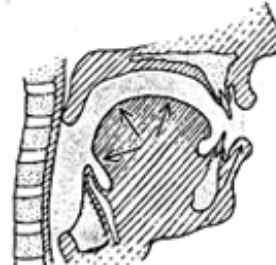
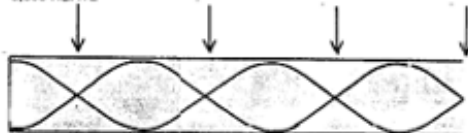

From Sundberg



Computing the 3 Formants of Schwa

- Let the length of the tube be L
 - $F_1 = c/\lambda_1 = c/(4L) = 35,000/4*17.5 = 500\text{Hz}$
 - $F_2 = c/\lambda_2 = c/(4/3L) = 3c/4L = 3*35,000/4*17.5 = 1500\text{Hz}$
 - $F_3 = c/\lambda_3 = c/(4/5L) = 5c/4L = 5*35,000/4*17.5 = 2500\text{Hz}$
- So we expect a neutral vowel to have 3 resonances at 500, 1500, and 2500 Hz
- These vowel resonances are called **formants**

Cross section of vocal tract

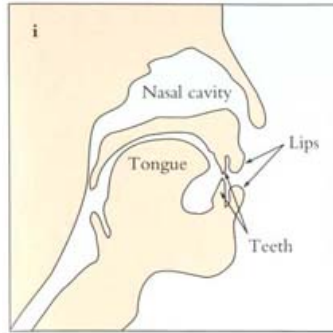

Model of vocal tract

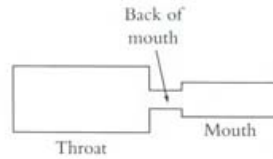

Acoustic spectrum

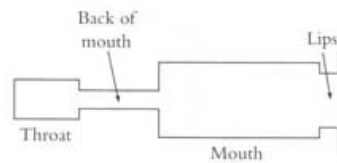
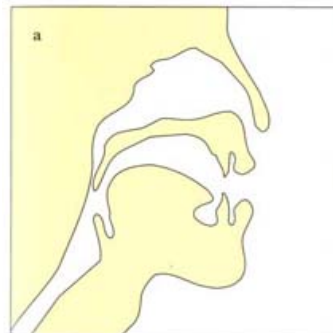
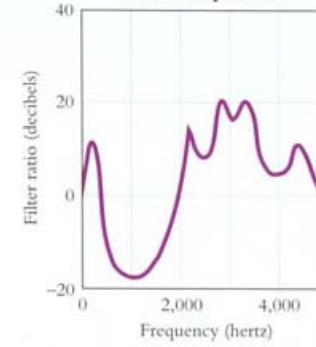

Acoustic spectrum

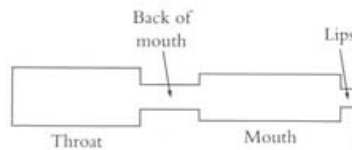
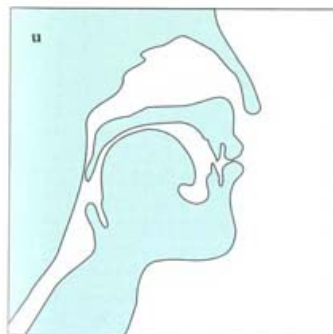
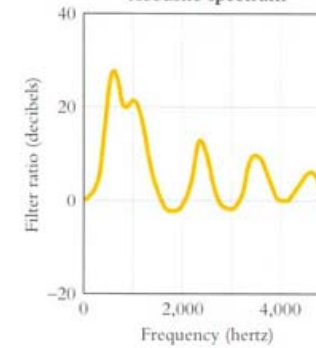

Acoustic spectrum

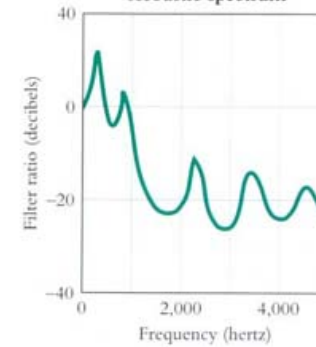

From
Mark
Liberman



Seeing Formants: the Spectrogram

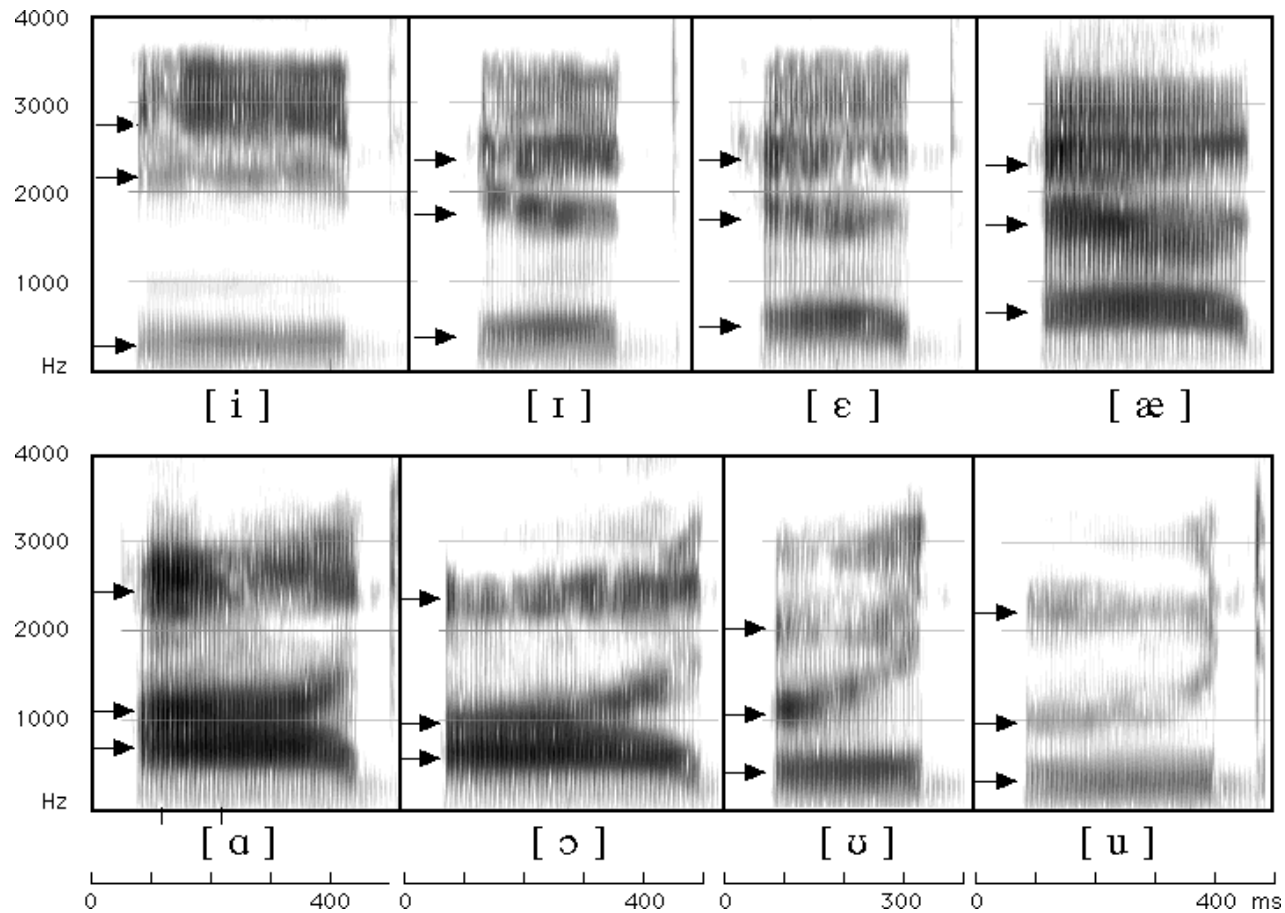



Vowel Space

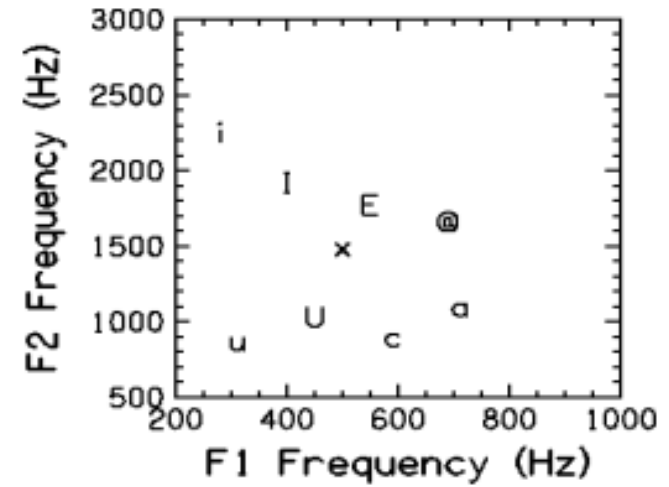
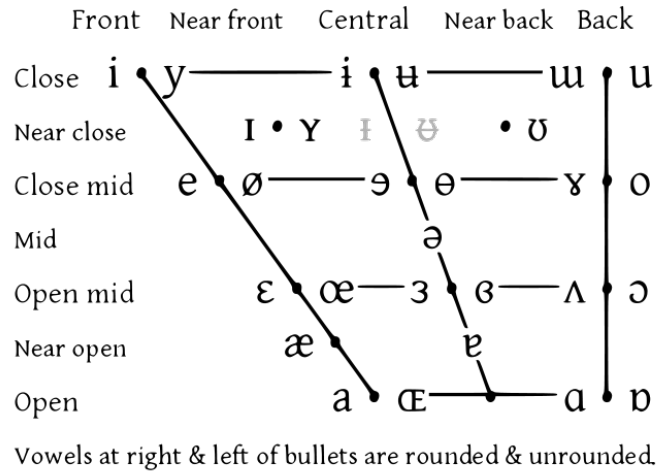

Spectrograms



How to Read Spectrograms

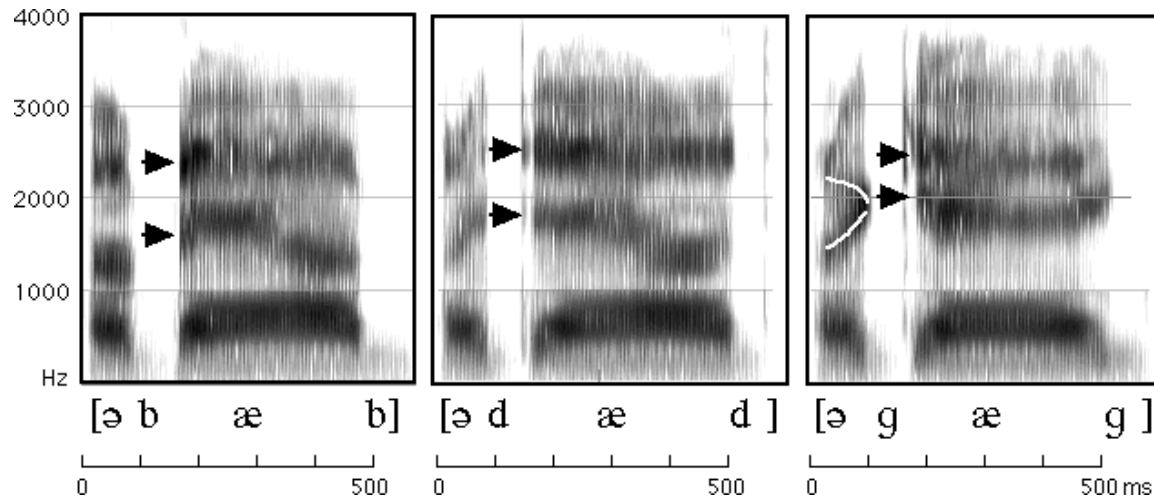

- [bab]: closure of lips lowers all formants: so rapid increase in all formants at beginning of "bab"
- [dad]: first formant increases, but F2 and F3 slight fall
- [gag]: F2 and F3 come together: this is a characteristic of velars. Formant transitions take longer in velars than in alveolars or labials

From Ladefoged "A Course in Phonetics"



“She came back and started again”

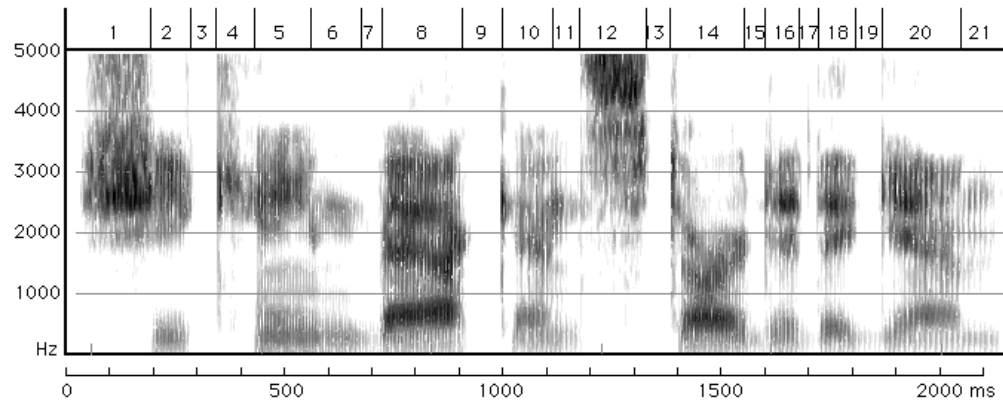

1. lots of high-freq energy

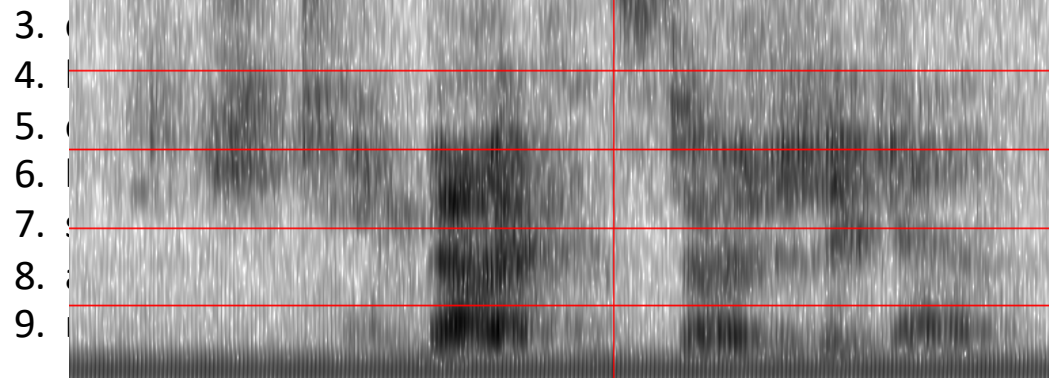

From Ladefoged “A Course in Phonetics”

Speech Recognition



Speech Recognition Architecture

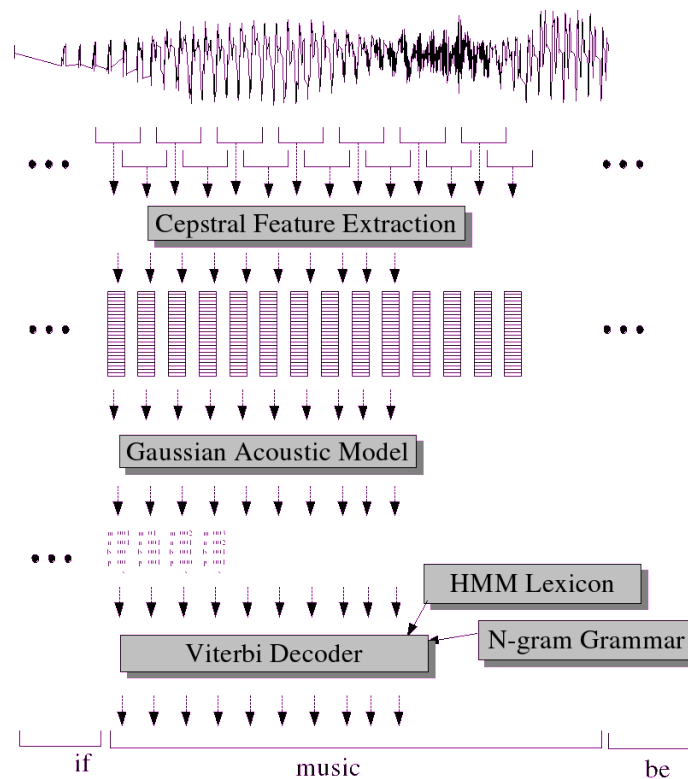

Figure: J & M

Feature Extraction



Digitizing Speech

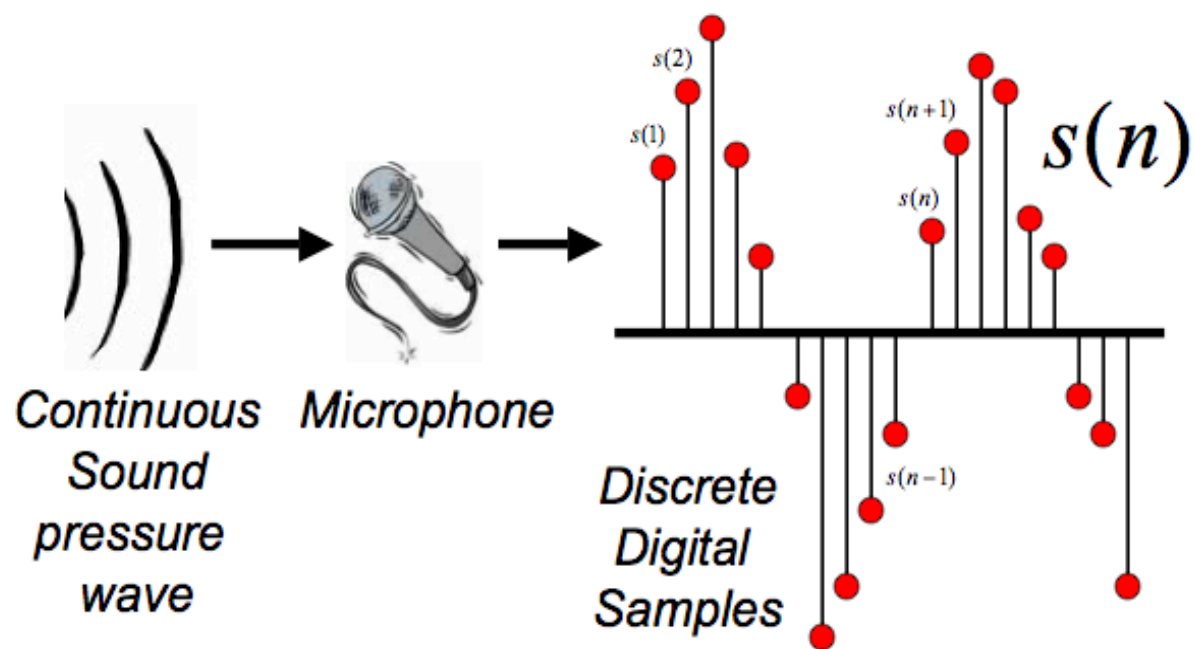

Figure: Bryan Pellom



Frame Extraction

- A 25 ms wide frame is extracted every 10 ms

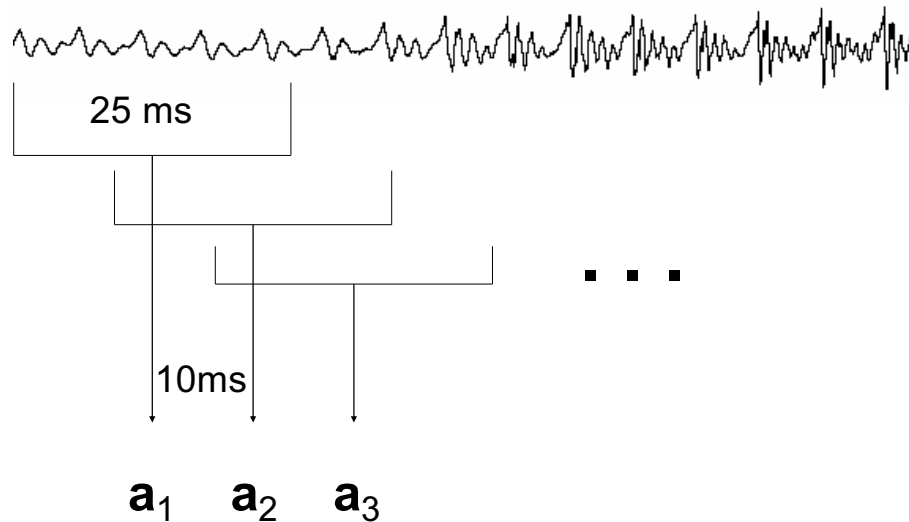
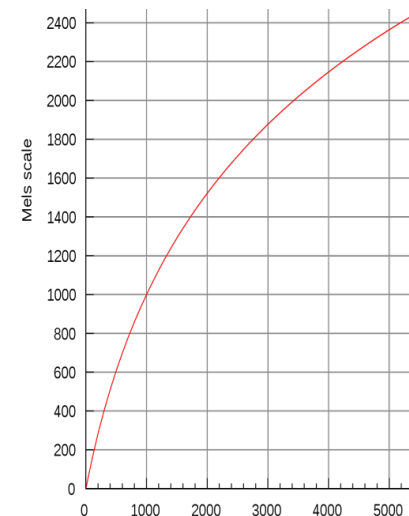
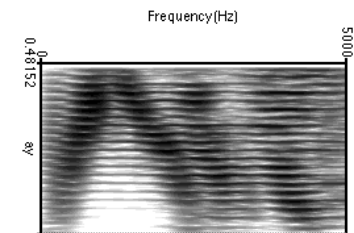

Figure: Simon Arnfield



Mel Freq. Cepstral Coefficients

- Do FFT to get spectral information
 - Like the spectrogram we saw earlier
- Apply Mel scaling
 - Models human ear; more sensitivity in lower freqs
 - Approx linear below 1kHz, log above, equal samples above and below 1kHz
- Plus discrete cosine transform



[Graph: Wikipedia]



Final Feature Vector

- 39 (real) features per 10 ms frame:
 - 12 MFCC features
 - 12 delta MFCC features
 - 12 delta-delta MFCC features
 - 1 (log) frame energy
 - 1 delta (log) frame energy
 - 1 delta-delta (log frame energy)
- So each frame is represented by a 39D vector

Emission Model



HMMs for Continuous Observations

- Solution 1: discretization
- Solution 2: continuous emission models
 - Gaussians
 - Multivariate Gaussians
 - Mixtures of multivariate Gaussians
- Solution 3: neural classifiers
- A state is progressively
 - Context independent subphone (~3 per phone)
 - Context dependent phone (triphones)
 - State tying of CD phone

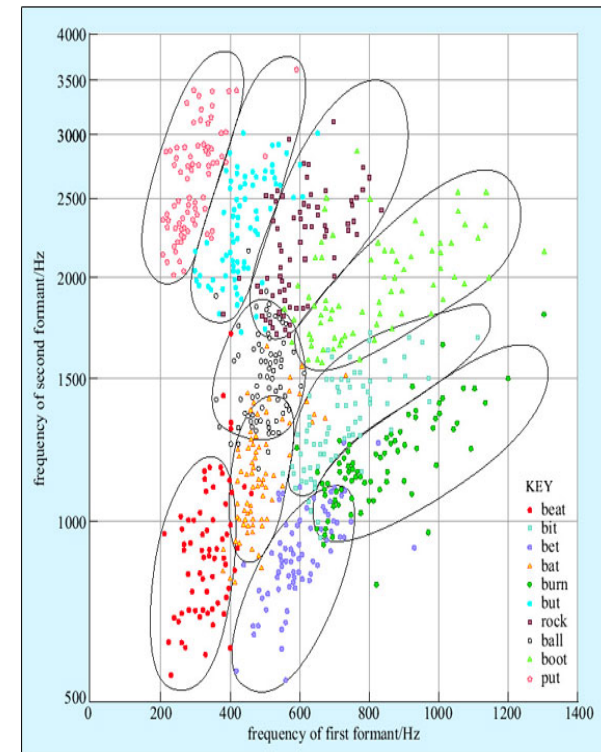



Vector Quantization

- Idea: discretization
 - Map MFCC vectors onto discrete symbols
 - Compute probabilities just by counting
- This is called vector quantization or VQ
- Not used for ASR any more
- But: useful to consider as a starting point, and for understanding neural methods

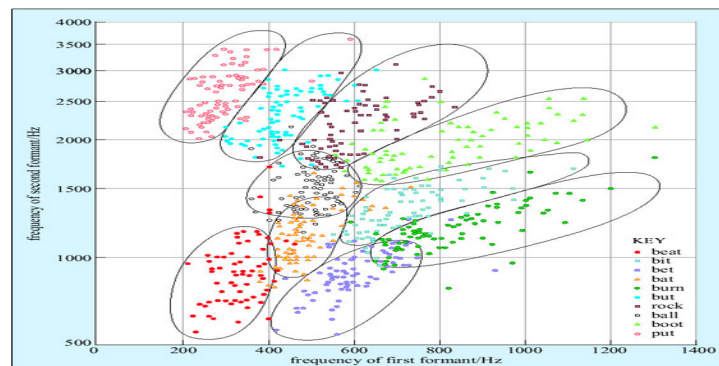
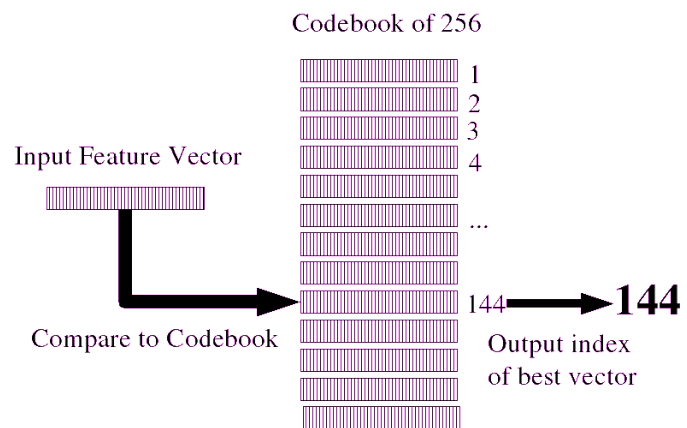



But we're not there yet

- Single Gaussians may do a bad job of modeling a complex distribution in any dimension
- Even worse for diagonal covariances
- Classic solution: mixtures of Gaussians
- Modern solution: NN-based acoustic models map feature vectors to (sub)states

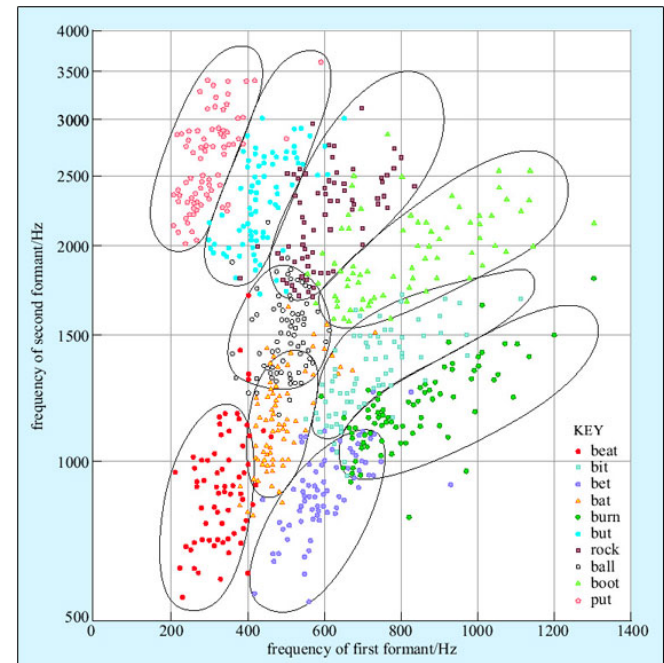

From openlearn.open.ac.uk

HMM / State Model



State Transition Diagrams

- Bayes Net: HMM as a Graphical Model

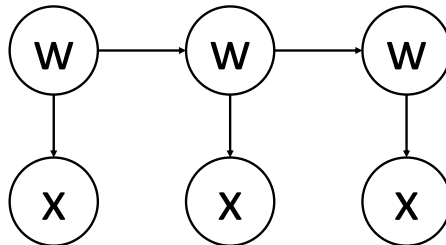

- State Transition Diagram: Markov Model as a Weighted FSA

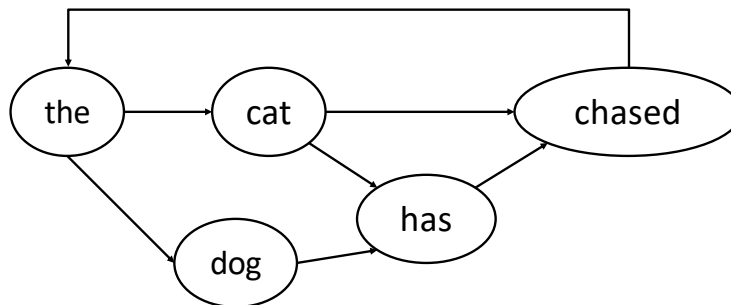



ASR Lexicon

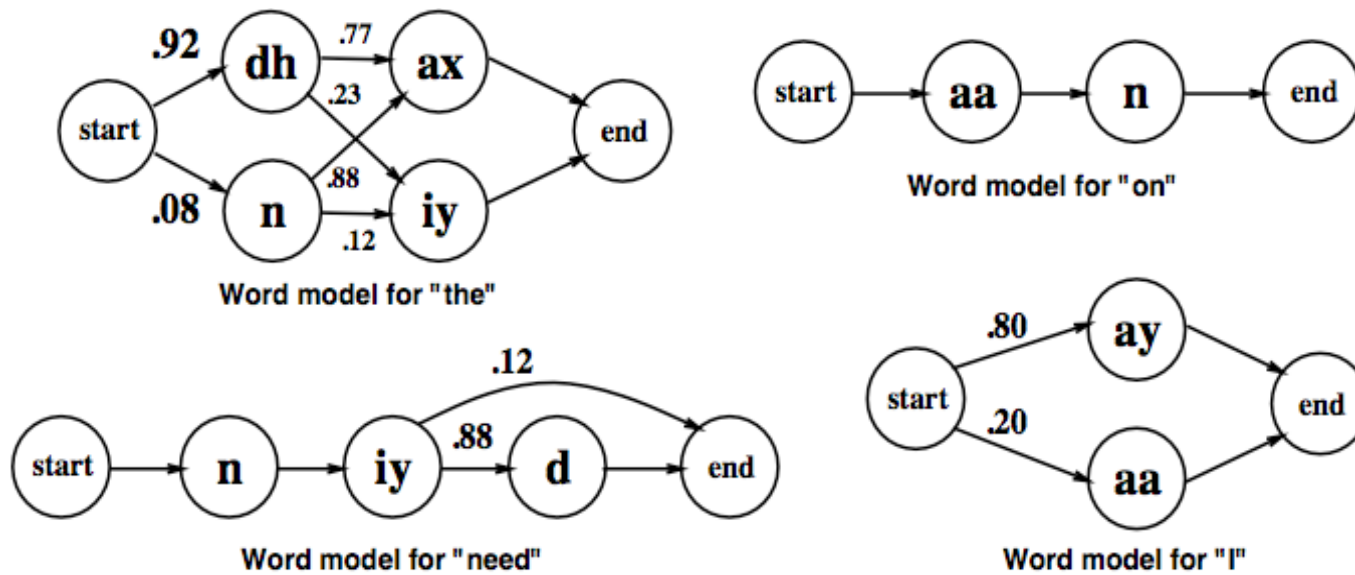

Figure: J & M



Lexical State Structure

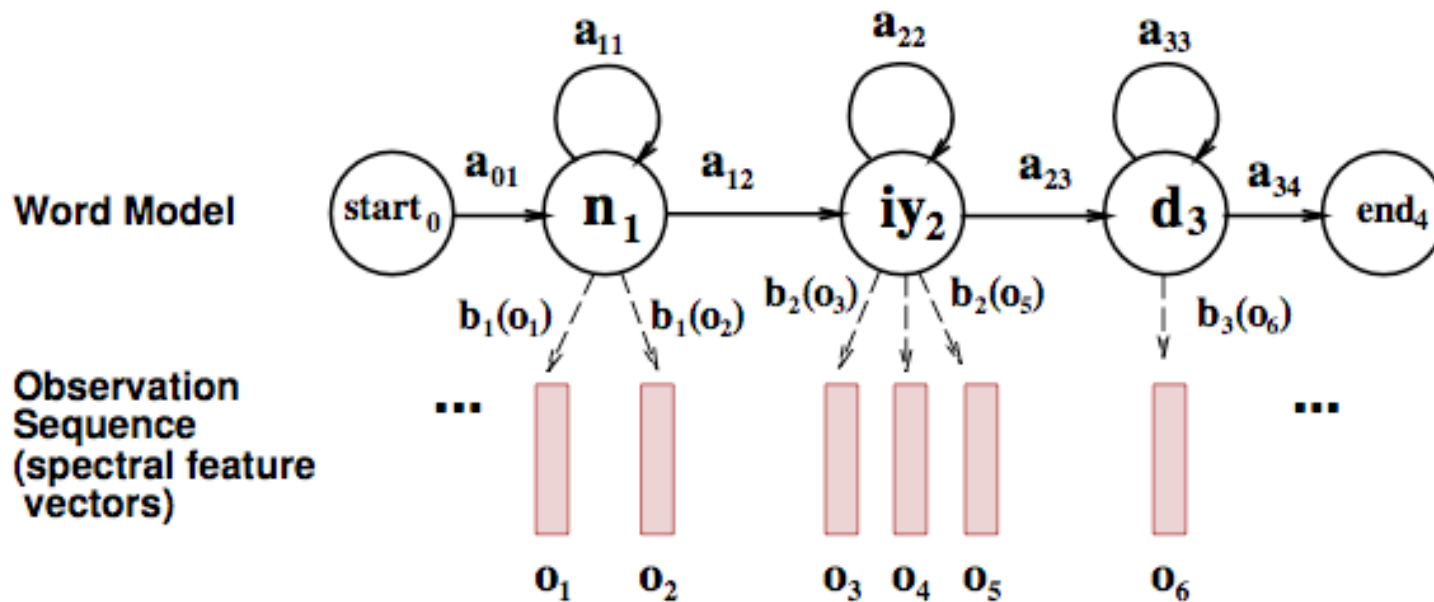

Figure: J & M



Adding an LM

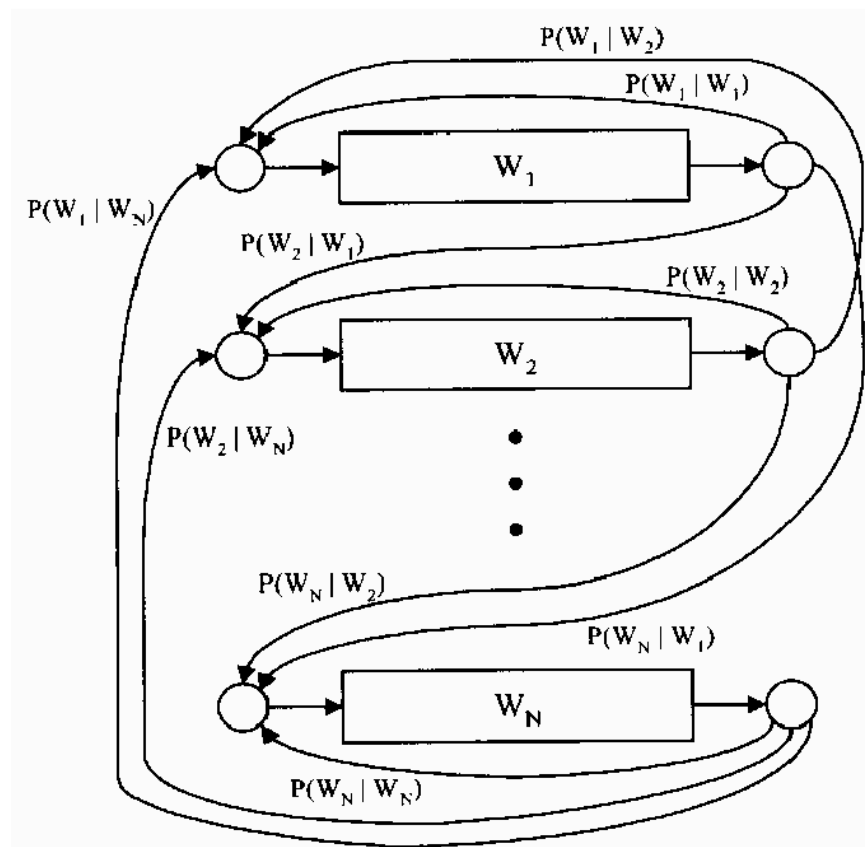

Figure from Huang et al page 618



State Space

- State space must include
 - Current word ($|V|$ on order of 50K+)
 - Index within current word ($|L|$ on order of 5)
 - E.g. (lec[t]ure) (though not in orthography!)
- Acoustic probabilities only depend on (contextual) phone type
 - E.g. $P(x|\text{lec[t]ure}) = P(x|t)$
- From a state sequence, can read a word sequence

State Refinement



Phones Aren't Homogeneous

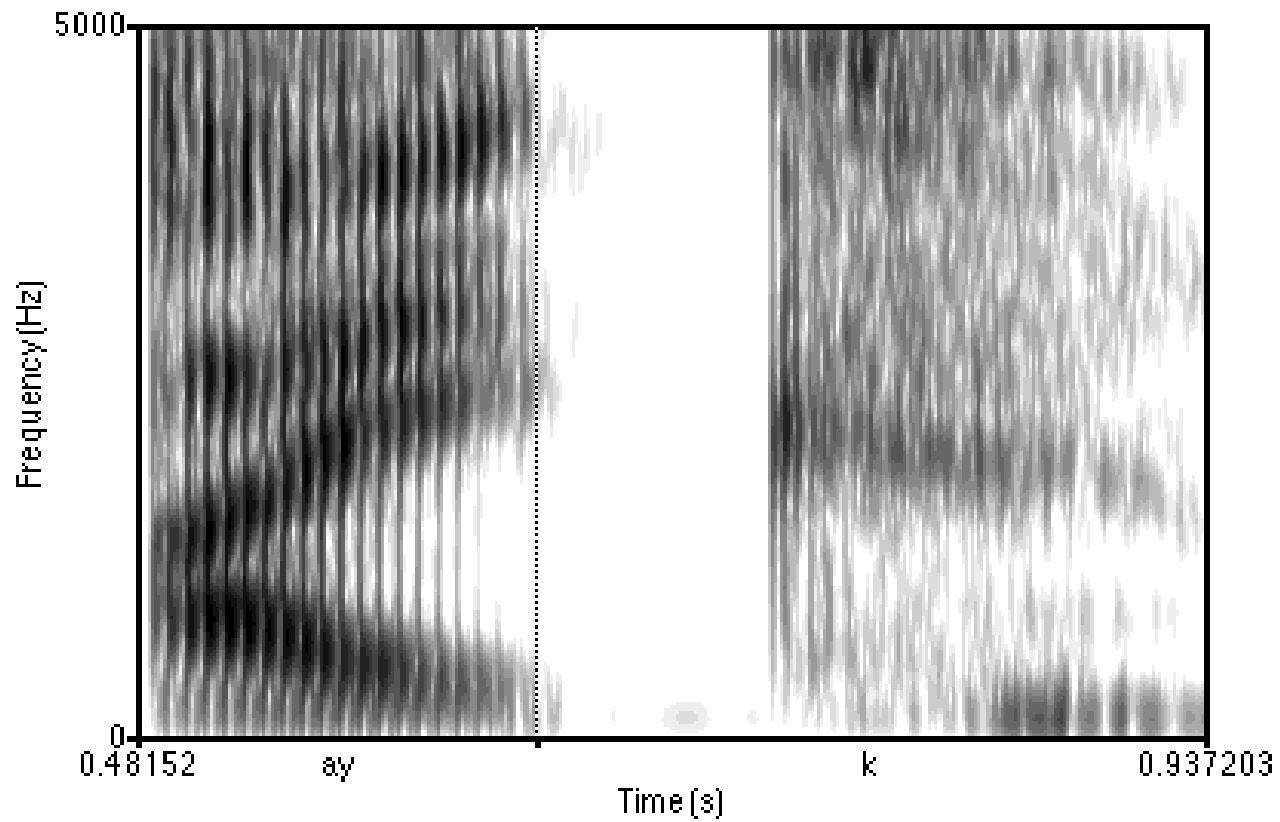



Subphones

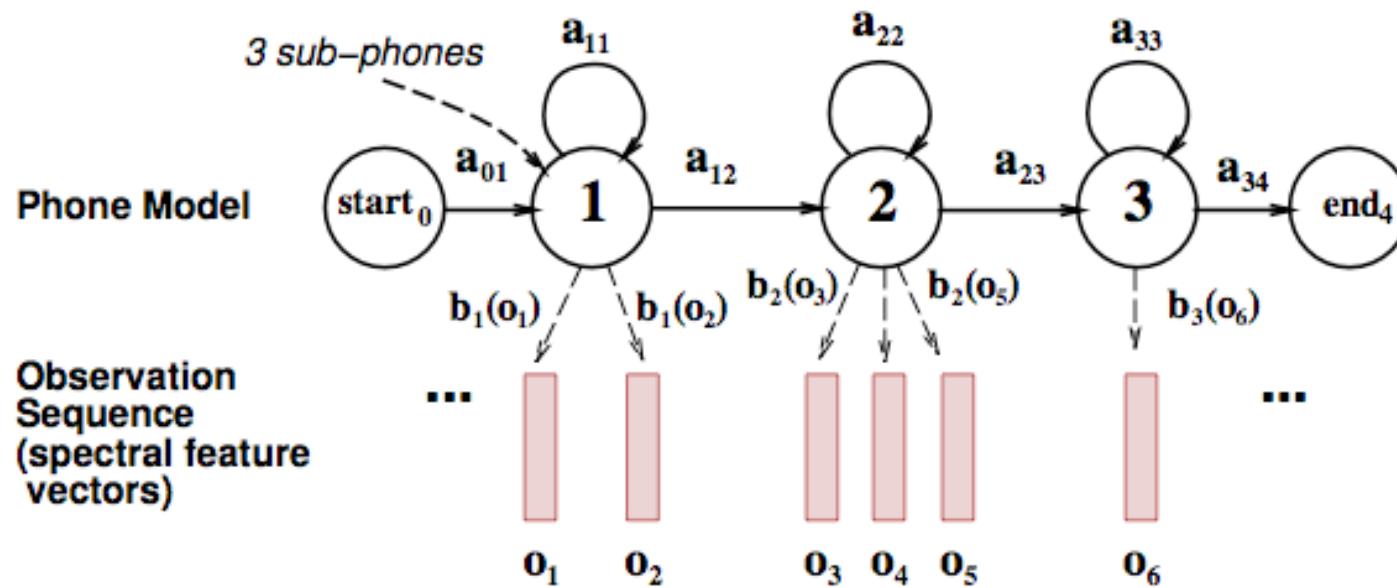

Figure: J & M



A Word with Subphones

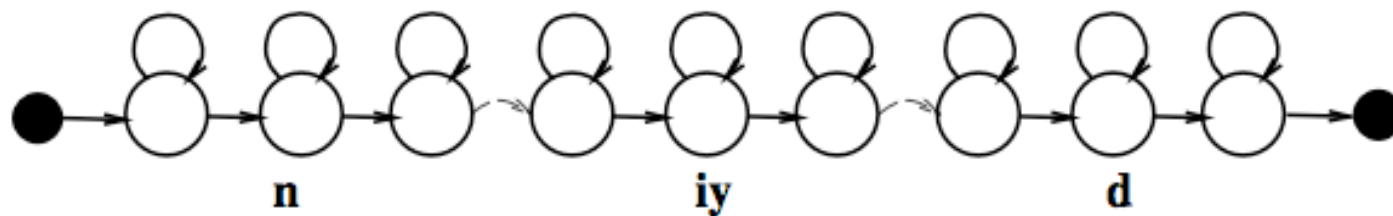

Figure: J & M



Modeling phonetic context

w iy

r iy

m iy

n iy

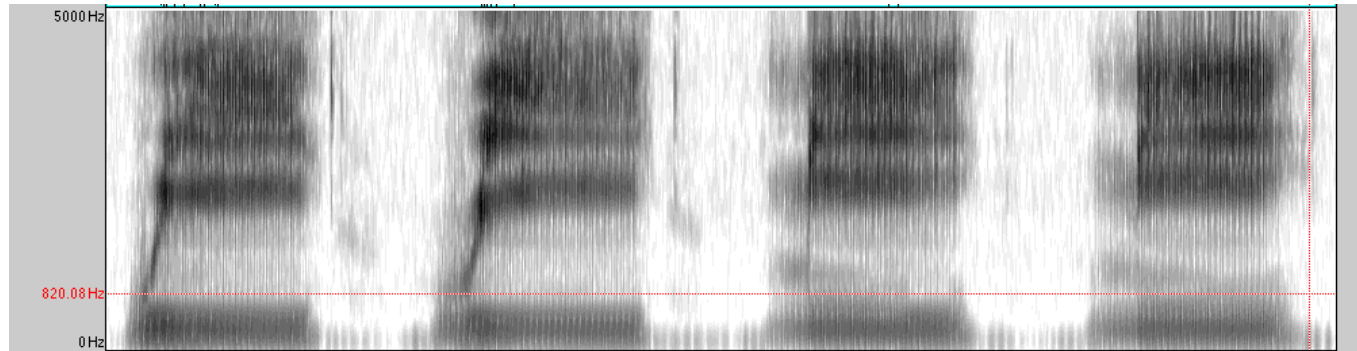



“Need” with triphone models

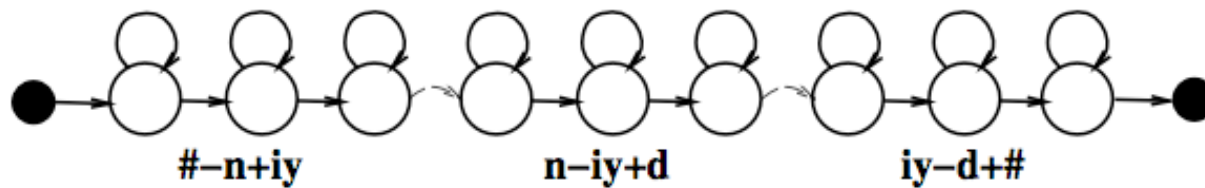

Figure: J & M



Lots of Triphones

- Possible triphones: $50 \times 50 \times 50 = 125,000$
- How many triphone types actually occur?
- 20K word WSJ Task (from Bryan Pellom)
 - Word internal models: need 14,300 triphones
 - Cross word models: need 54,400 triphones
- Need to generalize models, tie triphones



State Tying / Clustering

- [Young, Odell, Woodland 1994]
- How do we decide which triphones to cluster together?
- Use **phonetic features** (or 'broad phonetic classes')
- Stop
- Nasal
- Fricative
- Sibilant
- Vowel
- lateral

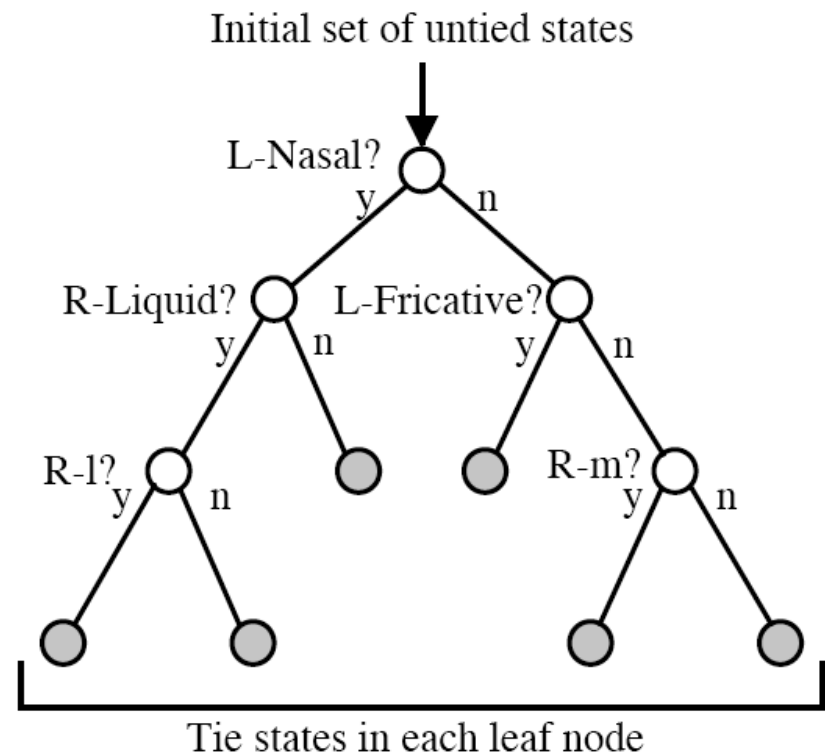

Figure: J & M



State Space

- Full state space

(LM context, lexicon index, subphone)

- Details:

- LM context is the past $n-1$ words
- Lexicon index is a phone position within a word (or a trie of the lexicon)
- Subphone is begin, middle, or end
- E.g. (after the, lec[t-mid]ure)

- Acoustic model depends on clustered phone context

- But this doesn't grow the state space

Learning Acoustic Models



What Needs to be Learned?

- Emissions: $P(x \mid \text{phone class})$

- X is MFCC-valued
- In neural methods, actually have $P(\text{phone} \mid \text{window around } x)$ and then coerce those scores into $P(x \mid \text{state})$

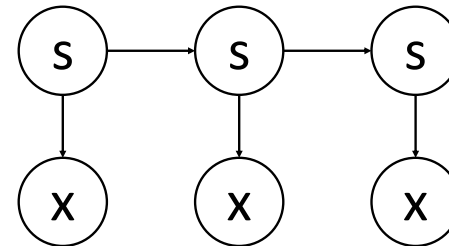

- Transitions: $P(\text{state} \mid \text{prev state})$

- If between words, this is $P(\text{word} \mid \text{history})$
- If inside words, this is $P(\text{advance} \mid \text{phone class})$
- (Really a hierarchical model)



Estimation from Aligned Data

- What if each time step were labeled with its (context-dependent sub) phone?

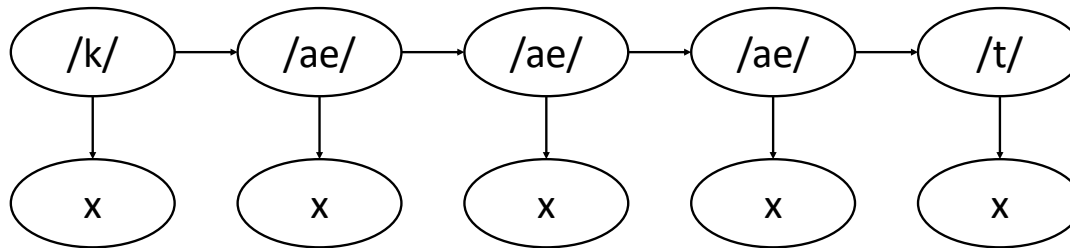

- Can estimate $P(x|/ae/)$ as empirical mean and (co-)variance of x 's with label /ae/, or mixture, etc/
- Problem: Don't know alignment at the frame and phone level



Forced Alignment

- What if the acoustic model $P(x|\text{phone})$ were known (or approximately known)?
 - ... and also the correct sequences of words / phones
- Can predict the best alignment of frames to phones

“speech lab”

sssssssspppppeeeeeetshshshshlllllaeaeaebbbb

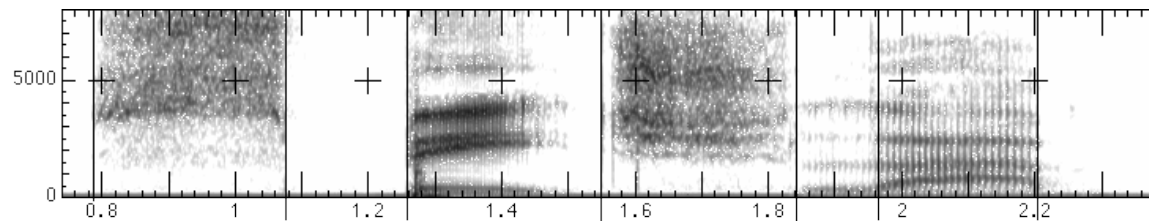

- Called “forced alignment”



Forced Alignment

- Create a new state space that forces the hidden variables to transition through phones in the (known) order

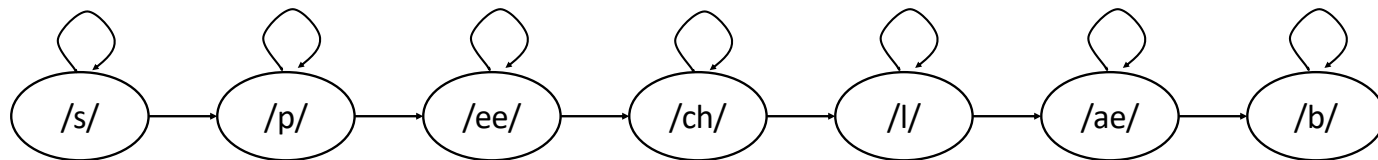

- Still have uncertainty about durations: this key uncertainty persists in neural models (and in some ways is worse now)
- In this HMM, all the parameters are known
 - Transitions determined by known utterance
 - Emissions assumed to be known
 - Minor detail: self-loop probabilities
- Just run Viterbi (or approximations) to get the best alignment



EM for Alignment

- Input: acoustic sequences with word-level transcriptions
- We don't know either the emission model or the frame alignments
- **Expectation Maximization**
 - Alternating optimization
 - Impute completions for unlabeled variables (here, the states at each time step)
 - Re-estimate model parameters (here, Gaussian means, variances, mixture ids)
 - Repeat
 - One of the earliest uses of EM for structured problems



Staged Training and State Tying

- **Creating CD phones:**
 - Start with monophone, do EM training
 - Clone Gaussians into triphones
 - Build decision tree and cluster Gaussians
 - Clone and train mixtures (GMMs)
- **General idea:**
 - Introduce complexity gradually
 - Interleave constraint with flexibility

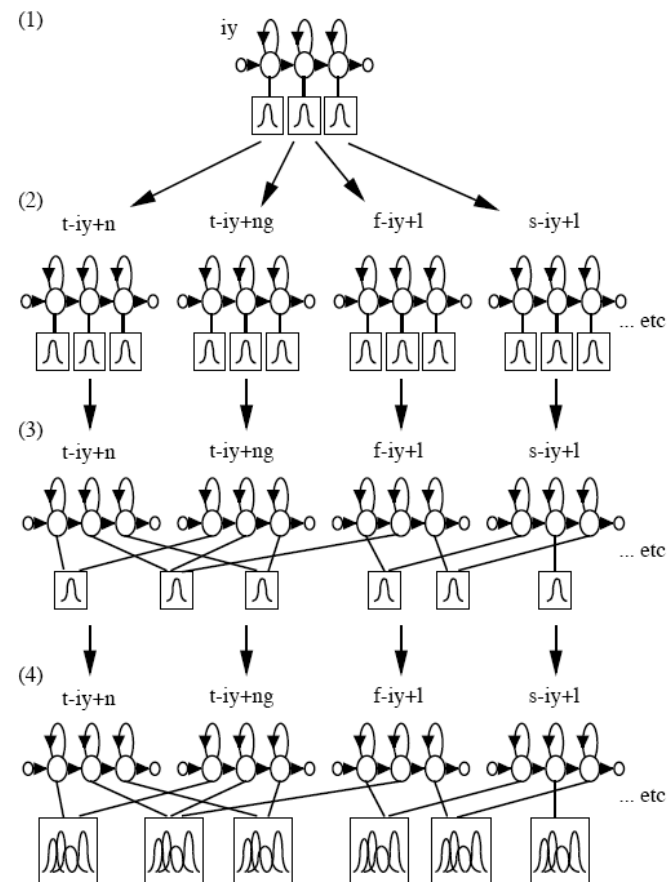



Neural Acoustic Models

- Given an input x , map to s ; this score coerced into generative $P(x|s)$ via Bayes rule (liberally ignoring terms)
- One major advantage of the neural is that you can look at many x 's at once to capture dynamics (important!)

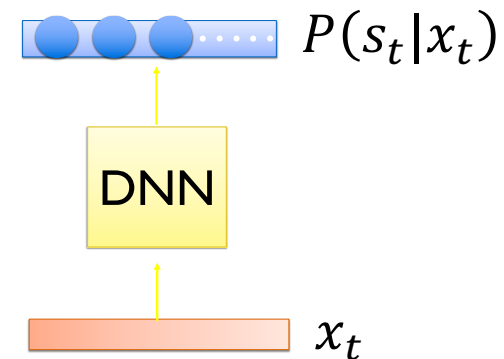

[Diagram from Hung-yi Li]

Decoding



State Trellis

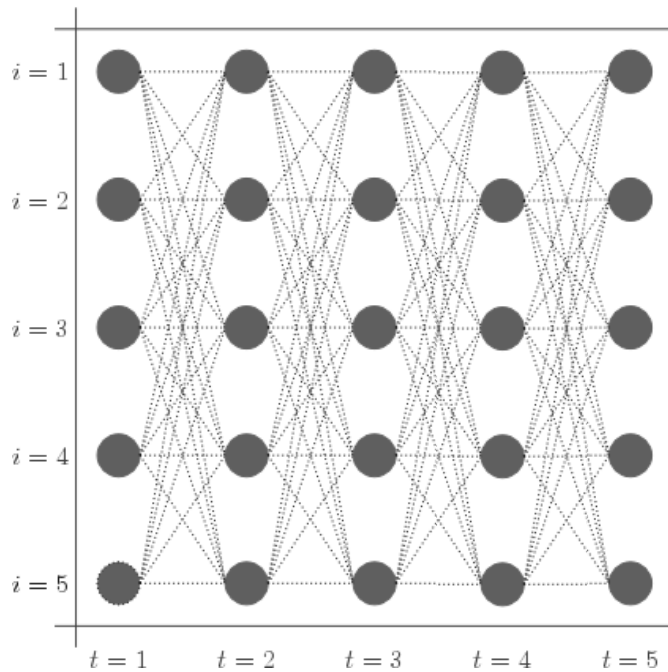

$$\phi_t(s_{t-1}, s_t) = P(x_t | s_t) P(s_t | s_{t-1})$$

$$\begin{aligned} P(x, s) &= \prod_i P(x_i | s_i) P(s_i | s_{i-1}) \\ &= \prod_i \phi_t(s_{i-1}, s_i) \end{aligned}$$

Figure: Enrique Benimeli



Beam Search

- Lattice is not regular in structure! Dynamic vs static decoding
- At each time step
 - Start: Beam (collection) v_t of hypotheses s at time t
 - For each s in v_t
 - Compute all extensions s' at time $t+1$
 - Score s' from s
 - Put s' in v_{t+1} replacing existing s' if better
 - Advance to $t+1$
- Beams are priority queues of fixed size* k (e.g. 30) and retain only the top k hypotheses



Dynamic vs Static Decoding

- **Dynamic decoding**
 - Build transitions on the fly based on model / grammar / etc
 - Very flexible, allows heterogeneous contexts easily (eg complex LMs)
- **Static decoding**
 - Compile entire subphone/vocabulary/LM into a huge weighted FST and use FST optimization methods (eg pushing, merging)
 - Much more common at scale, better eng and speed properties



Direct Neural Decoders

- Lots of work in decoders that skip explicit / discrete alignment
 - Decode to phone, or character, or word
 - Handle alignments softly (eg attention) or discretely (eg CTC)

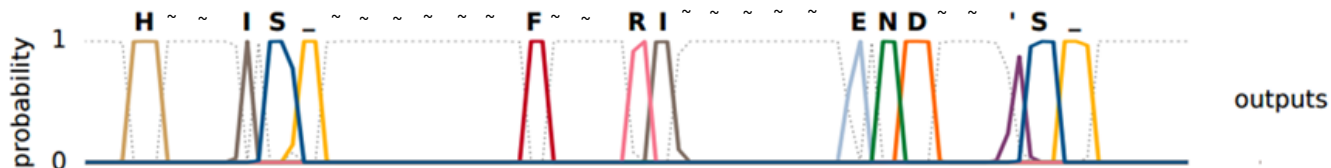

- Catching up but not yet as good as structured systems

[Diagram from Graves 2014]